

**BLUETECHNIX**  
Embedding Ideas

---

# Argos 3D - P310

---

Hardware User Manual

---

Version 1.4

---

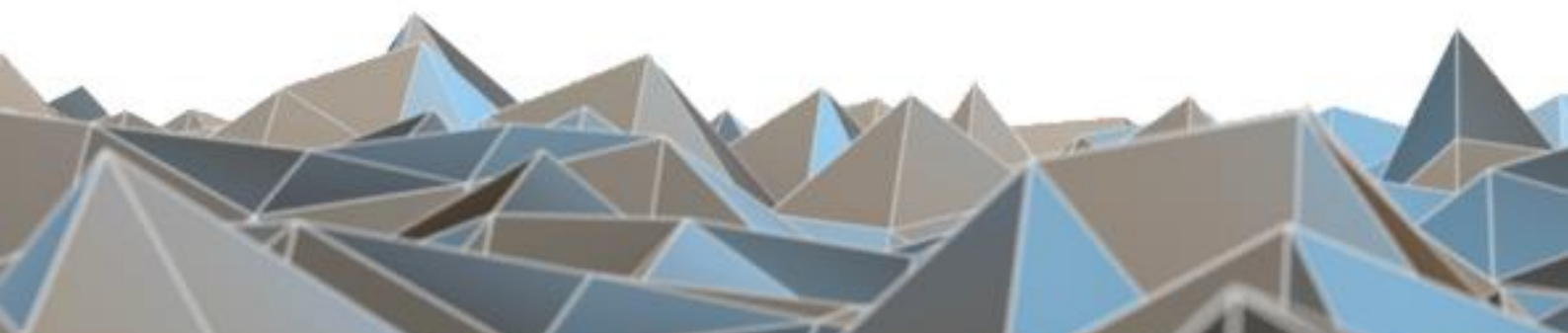
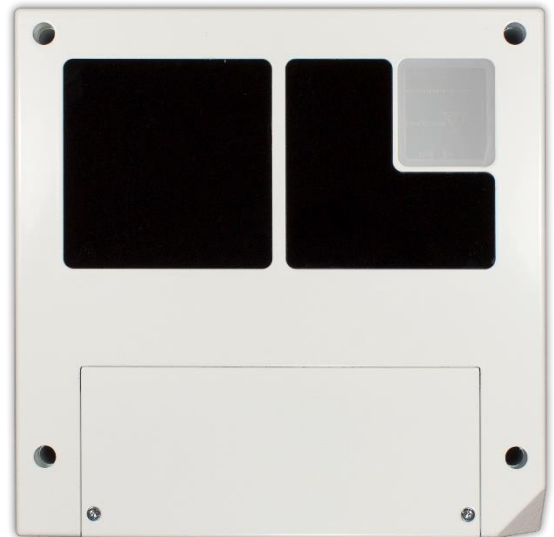



Bluetechnix

Waidhausenstraße 3/19  
A-1140 Vienna  
AUSTRIA

office@bluetechnix.com  
www.bluetechnix.com

Argos 3D - P310 – Hardware User Manual

Document No.: 900-308 / A

Publication date: April 17, 2015

Subject to change without notice. Errors excepted.

This document is protected by copyright. All rights reserved. No part of this document may be reproduced or transmitted for any purpose in any form or by any means, electronically or mechanically, without expressly written permission by Bluetechnix GmbH.

Windows is a registered trademark of Microsoft.



## Table of Contents

1	General Information.....	6
1.1	Symbols Used.....	6
1.2	Certification.....	7
1.2.1	CE Declaration.....	7
1.2.2	FCC Declaration.....	7
1.2.3	Eye Safety.....	7
	Illumination: LEDs.....	7
	Wavelength.....	7
	850nm (typ).....	7
	In accordance with EN62471:2008 resp. IEC62471:2006.....	7
	Output power.....	7
	TBD.....	7
1.3	Safety instructions.....	8
1.4	Electrical connection.....	8
2	Overview.....	9
2.1	Components.....	9
2.2	Interfaces and Connectors.....	10
3	Hardware Installation.....	11
3.1	Mounting.....	11
3.1.1	Mounting Holes (a).....	11
3.1.2	Mount Spacing.....	11
4	Board Description.....	12
4.1	Signal naming.....	12
4.2	Connector Numbering.....	12
4.3	Interface-Slot.....	12
4.3.1	Ethernet (a).....	13
4.3.2	General purpose output 1 & 2 (b).....	13
4.3.3	General purpose output 3 & 4 (c).....	13
4.3.4	General purpose input 1 & 2 (d).....	14
4.3.5	RS232/RS485 (e).....	14
4.3.6	CAN-Bus (f).....	15
4.3.7	Modulation Interface (LVDS) (g).....	15
4.3.8	DIP-Switch (h).....	16
4.3.9	Trigger and RS232 (i).....	16
4.3.10	Power Connector (j).....	16
4.3.11	I2C (c).....	17



---

4.3.12	Boot loader mode button (k)	17
4.3.13	Reset-Button (l)	17
4.3.14	USB (m)	17
5	Software	18
5.1	Firmware	18
5.2	Demo Application	18
5.3	Getting Started Software Development Example	18
6	Appendix	19
6.1	Operating Conditions	19
6.2	Mechanical Outline	19
7	Support	21
7.1.1	General Support	21
7.2	Software Packages	21
7.3	Related Products	21
8	Product History	22
8.1	Version Information	22
8.1.1	Argos3D-P310	22
8.2	Anomalies	22
8.3	Document Revision History	22
9	Index	23



© Bluetechnix 2015

All Rights Reserved.

The information herein is given to describe certain components and shall not be considered as a guarantee of characteristics.

Terms of delivery and rights of technical change reserved.

We hereby disclaim any warranties, including but not limited to warranties of non-infringement, regarding circuits, descriptions and charts stated herein.

Bluetechnix makes and you receive no warranties or conditions, express, implied, statutory or in any communication with you. Bluetechnix specifically disclaims any implied warranty of merchantability or fitness for a particular purpose.

Bluetechnix takes no liability for any damages and errors causing of the usage of this board. The user of this board is responsible by himself for the functionality of his application. He is allowed to use the board only if he has the qualification. More information is found in the General Terms and Conditions (AGB).

#### Information

For further information on technology, delivery terms and conditions and prices please contact Bluetechnix (<http://www.bluetechnix.com>).

#### Warning

Due to technical requirements components may contain dangerous substances.

## 1 General Information

This guide applies to the Argos 3D - P310 camera platform from Bluetechnix. Follow this guide chapter by chapter to set up and understand your product. If a section of this document only applies to certain camera parts, this is indicated at the beginning of the respective section.

### 1.1 Symbols Used

This guide makes use of a few symbols and conventions:



#### Warning

Indicates a situation which, if not avoided, could result in minor or moderate injury and/or property damage or damage to the device.



#### Caution

Indicates a situation which, if not avoided, may result in minor damage to the device, in malfunction of the device or in data loss.



#### Note

Notes provide information on special issues related to the device or provide information that will make operation of the device easier.

#### Procedures

##### A procedure always starts with a headline

1. The number indicates the step number of a certain procedure you are expected to follow. Steps are numbered sequentially.

This sign ► indicates an expected result of your action.

#### References

 This symbol indicates a cross reference to a different chapter of this manual or to an external document.

## 1.2 Certification

### 1.2.1 CE Declaration

Bluetechnix hereby declares that this Argos 3D - P310 product is in compliance with the essential requirements and other relevant provisions of Directive 2004/108/EC.



### 1.2.2 FCC Declaration

This device complies with part 15 of the FCC rules. Operation is subject to the following two conditions: (1) this device may not cause harmful interference, and (2) this device must accept any interference received, including interference that may cause undesired operation.

This equipment has been tested and found to comply with the limits for a Class A digital device, pursuant to part 15 of the FCC Rules. These limits are designed to provide reasonable protection against harmful interference when the equipment is operated in a commercial environment. This equipment generates, uses, and can radiate radio frequency energy and, if not installed and used in accordance with the instruction manual, may cause harmful interference to radio communications. Operation of this equipment in a residential area is likely to cause harmful interference in which case the user will be required to correct the interference at his own expense.



FCC ID: SSZA3DP31015020  
 Trade Name: Bluetechnix Group GmbH  
 Model: Argos 3D – P310



#### Classification of ITE (EN55022)

This is a class A product. In a domestic environment this product may cause radio interference in which case the user may be required to take adequate measures.

### 1.2.3 Eye Safety

<b>Illumination: LEDs</b>	<b>Wavelength</b>	850nm (typ)	In accordance with EN62471:2008 resp. IEC62471:2006
	<b>Output power</b>	TBD	



### 1.3 Safety instructions



#### Important

This manual is part of the device and contains information and illustrations about the correct handling of the device and must be read before installation or use. Observe the operating instructions. Non-observance of the instructions, operation which is not in accordance with use as prescribed below, wrong installation or handling can affect the safety of people and machinery.

The installation and connection must comply with the applicable national and international standards. Responsibility lies with the person installing the unit.

### 1.4 Electrical connection



#### Note

The unit must be connected by a qualified electrician.

Device of protection class III (PC III).

The electric supply must only be made via PELV circuits.

The device must only be powered by a limited energy source ( $\leq 30V$ ;  $\leq 8A$ ;  $\leq 100VA$ ).

Disconnect power before connecting the unit.





## 2 Overview

### 2.1 Components

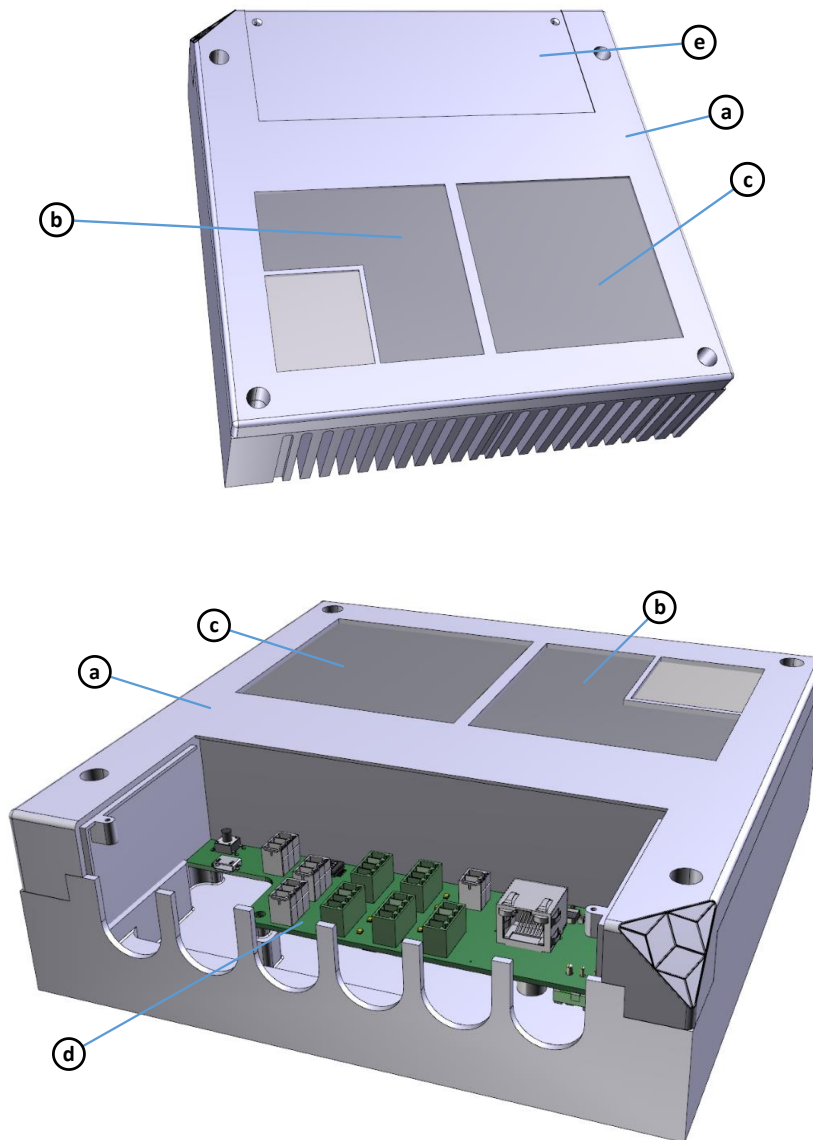
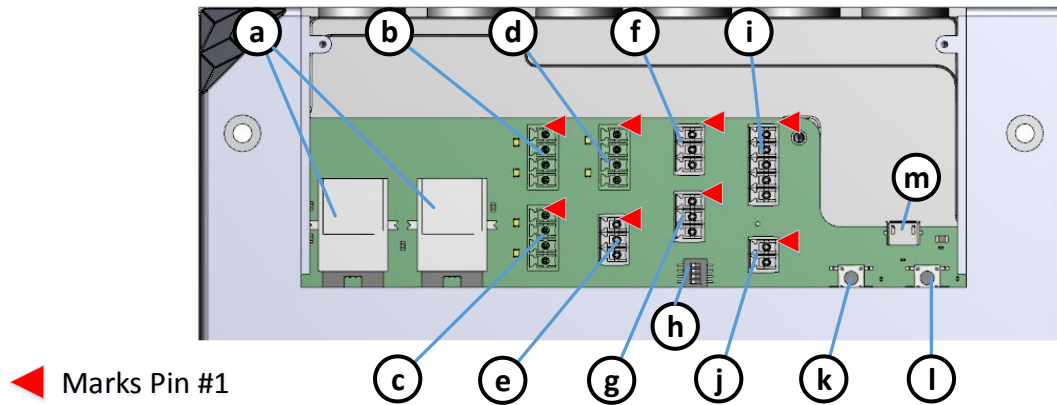

Figure 2-1 Argos3D-P310 components

- a. Case
- b. Viewing window for 3D sensor
- c. Viewing window for illumination module
- d. Interface board
- e. Interface cover

## 2.2 Interfaces and Connectors



Argos3D-P310 connectors and interfaces

Figure 2-2:

- a. Ethernet (RJ45) 10/100/Base-T
- b. General purpose outputs, galvanic isolated
- c. General purpose outputs, galvanic isolated
- d. General purpose inputs, galvanic isolated
- e. RS232/485
- f. CAN-Bus
- g. Modulation Light Interface
- h. DIP-Switch
- i. Trigger, UART
- j. Power supply \*
- k. Boot loader mode button
- l. Reset button
- m. USB

\* The socket-outlet shall be installed near the equipment and shall be easily accessible.



### 3 Hardware Installation

#### 3.1 Mounting



**Caution**

Case may become hot!

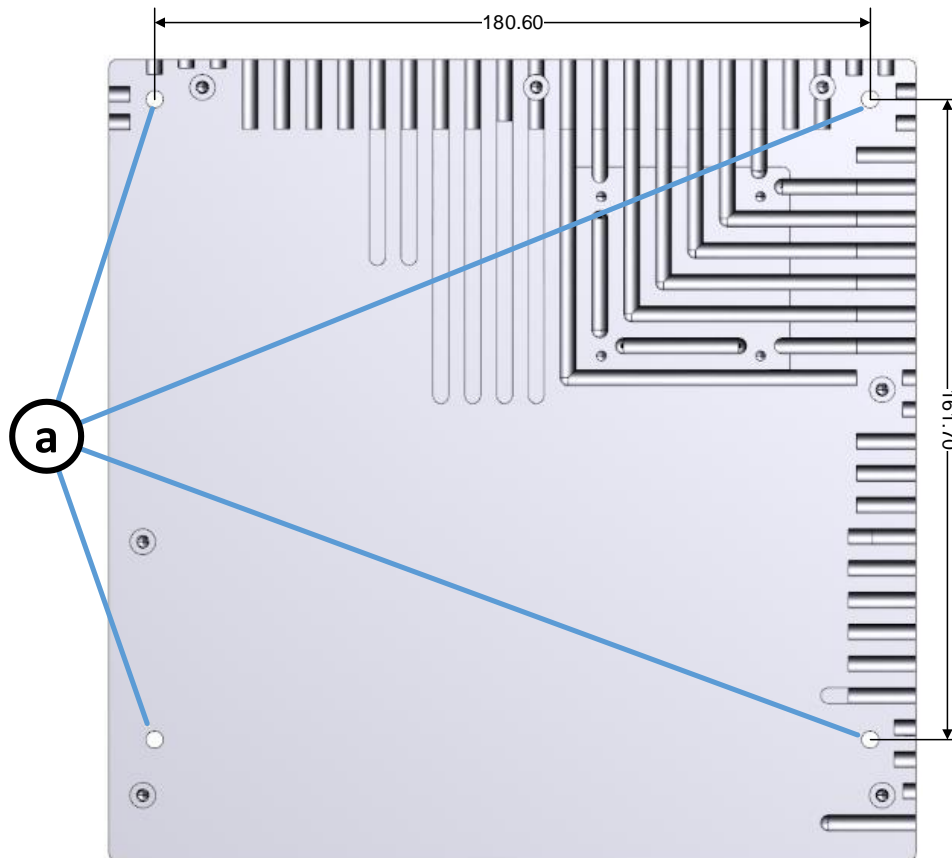

Figure 3-1: Mounting holes for the case

##### 3.1.1 Mounting Holes (a)

The case has four M3 holes that allows mounting the Argos3D-P310.

##### 3.1.2 Mount Spacing

The device is primarily intended for mounting on a wall or the ceiling. Leave enough space for air circulation.

## 4 Board Description

### 4.1 Signal naming

Signal names are usually written in capital letters. They are noted in positive logic (positive asserted). If the signal is negative asserted an “n” will be added as prefix to the signal name.

#### Type:

The type describes the electrical characteristics of the signal. The following types are available:

- I            Input
- O            Output
- DN          Negative Differential Output
- DP          Positive Differential Output
- P            Power supply
- 3.3V TTL    TTL compatible signal with 3.3V high level and 0V low level
- 5V tolerant    Accepts 5V input level

### 4.2 Connector Numbering

All pins no. 1 of each connector are marked in the figures with a red arrow. The connector numbering always starts at this pin, continuing in this row, and going backwards at the opposite side.



### 4.3 Interface-Slot

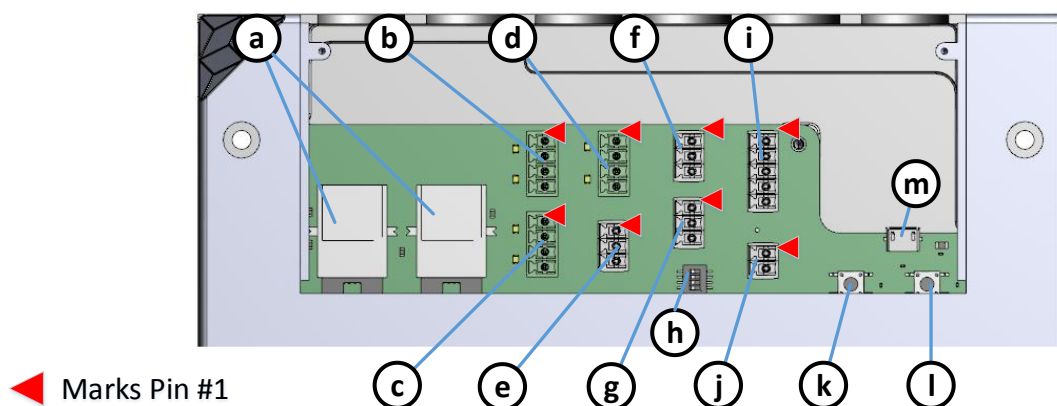

Figure 4-1: Argos3D-P310 connector location

### 4.3.1 Ethernet (a)

These are standard straight RJ45 10/100 Base-T compatible Ethernet connectors. They are connected to an Ethernet switch.

Both Ethernet connectors can be used to connect multiple cameras in a daisy chain.

### 4.3.2 General purpose output 1 & 2 (b)

This 4 pole 3.5mm terminal connector allows plugging a cable entry plug like **691361100004** from Würth Elektronik.

No.	Signal	Type	Description
1	OUT1A	SPST-A	Relay contact A
2	OUT1B	SPST-B	Relay contact B
3	OUT2A	SPST-A	Relay contact A
4	OUT2B	SPST-B	Relay contact B

Table 4-1: General purpose output 1 & 2 connector description

A solid state relay ASSR-3210 from Avago Technologies is used for each general purpose output.

Voltage range: 18V to 30V.

Current range: 0mA to 200mA.



#### Note

The cable length should not exceed 3m.

### 4.3.3 General purpose output 3 & 4 (c)

This 4 pole 3.5mm terminal connector allows plugging a cable entry plug like **691361100004** from Würth Elektronik.

No.	Signal	Type	Description
1	OUT3A	SPST-A 0V to 30V	Relay contact A
2	OUT3B	SPST-B 0V to 30V	Relay contact B
3	OUT4A	SPST-A 0V to 30V	Relay contact A
4	OUT4B	SPST-B 0V to 30V	Relay contact B

Table 4-2: General purpose output 3 & 4 connector description

A solid state relay ASSR-3210 from Avago Technologies is used for each general purpose output.

Voltage range: 18V to 30V.

Current range: 0mA to 200mA.

**Note**

The cable length should not exceed 3m.

#### 4.3.4 General purpose input 1 & 2 (d)

This 4 pole 3.5mm terminal connector allows plugging a cable entry plug like **691361100004** from Würth Elektronik.

No.	Signal	Type	Description
1	IN2A	I 0V to 50V	Relay contact A
2	IN2B	I 0V to 50V	Relay contact B
3	IN1A	I 0V to 50V	Relay contact A
4	IN1B	I 0V to 50V	Relay contact B

Table 4-3: General purpose input 1 & 2 connector description

An opto-coupler SFH6286-2T from Vishay is used for each general purpose input.

OFF-Range: 0V to 2V.

ON-Range: 5V to 50V.

**Note**

The cable length should not exceed 3m.

#### 4.3.5 RS232/RS485 (e)

This 3 pole 3.5mm terminal connector allows plugging a cable entry plug like **691361100003** from Würth Elektronik.

No.	Signal	Type	Description
1	GND	P	Signal Ground
2	RS232 RxD <sup>1)</sup>	IO	RS232 Receive Data
	RS485 A/Y	DN	RS485 Negative Differential Data
3	RS232 TxD <sup>1)</sup>	IO	RS232 Transmit Data
	RS485 B/Z	DP	RS485 Positive Differential Data

Table 4-4: GPIO Connector Description

<sup>1)</sup> The interface mode can be selected with the DIP-Switch (see chapter 4.3.8).

The RS232 interface is running in full duplex mode and the RS485 is running in half duplex mode.



**Note**

The cable length should not exceed 60m.

### 4.3.6 CAN-Bus (f)

This 3 pole 3.5mm terminal connector allows plugging a cable entry plug like **691361100003** from Würth Elektronik.

No.	Signal	Type	Description
1	CAN_P	DP	CAN H
2	CAN_N	DN	CAN L
3	GND	P	Power Ground

Table 4-5: CAN-Bus connector description



**Note**

The cable length should not exceed 60m.

### 4.3.7 Modulation Interface (LVDS) (g)

This 3 pole 3.5mm terminal connector allows plugging a cable entry plug like **691361100003** from Würth Elektronik.

No.	Signal	Type	Description
1	GND	P	Power ground
2	MOD_P	DP	Modulation signal output+
3	MOD_N	DN	Modulation signal output-

Table 4-6: Modulation Interface connector description

The Modulation Interface provides the modulation signal for an external illumination module (differential LVDS).



**Note**

The cable length should not exceed 50cm.



**Caution**

Overvoltage on the Modulation Interface will destroy the Argos3D-P310.

### 4.3.8 DIP-Switch (h)

The DIP-Switch allows configuring the RS232/RS485 transceiver and the CAN-Bus. The following table shows the functionality of each switch.

No.	Name	Description
1	CAN Termination	ON: Enables the 120Ω CAN-Bus termination resistor OFF: No termination resistor is active
2	RS485 Enable	ON: Transceiver works in RS485 mode OFF: Transceiver works in RS232 mode
3	-	Not used
4	RS485 Termination	ON: Enables the 120Ω RS485 termination resistor OFF: No termination resistor is active

Table 4-7: DIP-Switch Description

#### Note

Make sure that the termination resistor is always disabled, if the driver runs in RS232 mode.

### 4.3.9 Trigger and RS232 (i)

This 5 pole 3.5mm terminal connector allows plugging a cable entry plug like **691361100005** from Würth Elektronik.

No.	Signal	Type	Description
1	TriggerOUT	OD 10k pull-up to 5V	Trigger Output
2	TriggerIN	I	Trigger Input (for input voltages refer to Table 6-1)
3	GND	P	Power ground
4	RS232 RxD	IO	RS232 Receive Data
5	RS232 TxD	IO	RS232 Transmit Data

Table 4-8: Trigger connector description

#### Note

The usage of this interface may depend on the firmware version.

### 4.3.10 Power Connector (j)

This 3.5mm terminal connector allows plugging a cable entry plug like **691361100002** from Würth Elektronik. Compatible connectors from other manufacturers may be found as well.

No.	Signal	Type	Description
1	VIN	P	Positive power supply
2	GND	P	Power ground

Table 4-9: Power connector description





The pins of the power connector are protected against wrong polarity.

Voltage range: 12V to 30V



**Warning**

Use inherently limited power sources only!

### 4.3.11 I2C (c)

This 4 pole 3.5mm terminal connector allows plugging a cable entry plug like **691361100004** from Würth Elektronik.

No.	Signal	Type	Description
1	GND	P	Signal Ground
2	3V3	P	3V3 Power supply (max. 25mA Output)
3	SCL	O 3.3V TTL	I2C Clock (2k2 pull-up to 3V3)
4	SDA	I/O 3.3V TTL	I2C Data (2k2 pull-up to 3V3)

Table 4-10: I2C Connector Description



**Note**

The cable length should not exceed 60m.

### 4.3.12 Boot loader mode button (k)

This button can be used to start the Argos3D-P310 in boot loader mode.

For further information about the boot loader function see Software User Manual of the Argos3D-P310.

### 4.3.13 Reset-Button (l)

This button can be used to perform a hardware reset and a factory default reset.

For further information about the factory default reset function see Software User Manual of the Argos3D-P310.

### 4.3.14 USB (m)

This USB micro connector can be directly connected to a host computer.

For further information about the USB function see Software User Manual of the Argos3D-P310.



## 5 Software

### 5.1 Firmware

For a description of the firmware related interfaces, protocol descriptions, register settings, etc. please refer to the Software User Manual.

### 5.2 Demo Application

Demo applications for a first bringup of the device can be found at the support site.

#### Software and documentation

 <https://support.bluetechnix.com>

### 5.3 Getting Started Software Development Example

To facilitate the integration of the Argos camera in your own application a getting started example will be available on our support site.

#### Software and documentation

 <https://support.bluetechnix.com>



## 6 Appendix

### 6.1 Operating Conditions

Symbol	Parameter	Min	Typical	Max	Unit
$V_{IN}$	Input supply voltage	12	24	30	V
$P_{IN}$	Input power	-	-	60	W
T	Operating Temperature	-20		55	°C
T	Storage Temperature	-40		+125	°C
TRIGGER_IN <sub>MAX</sub>	Maximum Trigger Input Voltage	-	30	-	V
TRIGGER_IN <sub>LOW</sub>	Trigger Input Threshold Low		2.2		V
TRIGGER_IN <sub>High</sub>	Trigger Input Threshold High		1		V

Table 6-1: Operating Conditions



#### Note

Refer to the anomaly list for anomalies regarding the operating conditions.

### 6.2 Mechanical Outline

All dimensions are given in mm.

Mechanical outline of the 'Bounding Box':

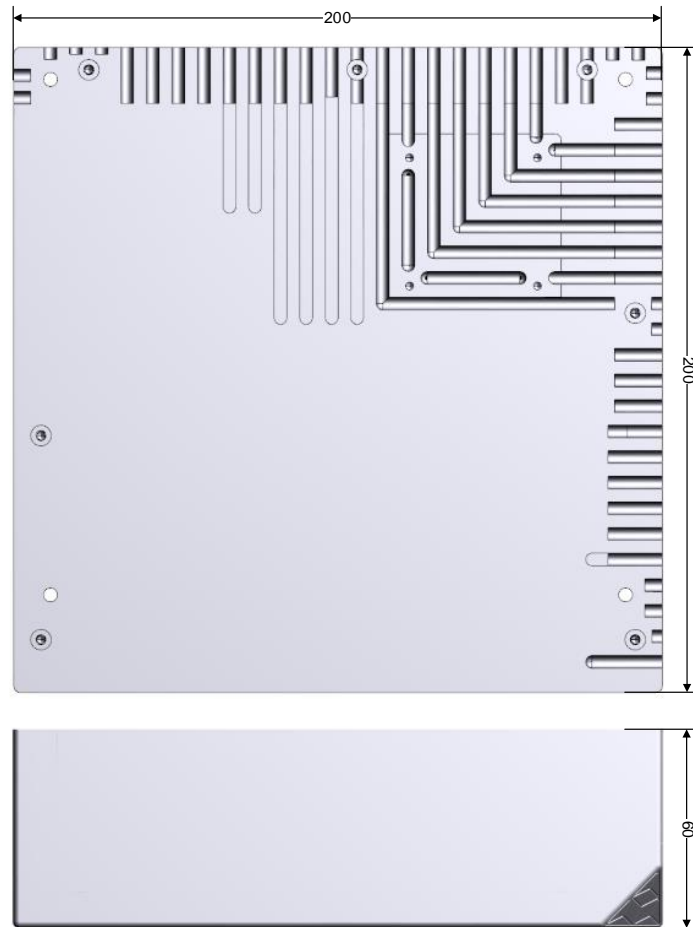

Figure 6-1: Mechanical outline of the bounding box



## 7 Support

### 7.1.1 General Support

General support for products can be found at Bluetechnix' support site

#### Support Link

 <https://support.bluetechnix.at/wiki/>

### 7.2 Software Packages

Software packages and software downloads are for registered customers only

#### Software Package

 <https://support.bluetechnix.at/software/>

### 7.3 Related Products

- TIM<sup>UP</sup>-19kS3-Spartan6
- LIM<sup>U</sup>-LED-850



## 8 Product History

### 8.1 Version Information

#### 8.1.1 Argos3D-P310

Version	Comment
0.0.0 X-Grade	Initial engineering sample.
1.0.0 X-Grade	New hardware and casing revision

Table 8-1: Overview Argos 3D - P310 product changes

#### Note



Please refer to our support site for additional information about product changes.

### 8.2 Anomalies

Applies to	Date	Description
V0.0.0 X-Grade		Maximum voltage on TRIGGER_IN pin 12V instead of 30V
V1.0.0 X-Grade		No anomalies reported yet

Table 8-2 – Product anomalies

### 8.3 Document Revision History

Version	Date	Document Revision
1	2014 07 14	First preliminary of the document
2	2014 07 29	Input voltage of TRIGGER_IN pin corrected.
3	2014 10 10	Cable length specification added. Anomaly list updated. Version information updated.
4	2014 10 30	Minor changes

Table 8-3: Revision history



## 9 Index

---

### A

Anomalies ..... 22

---

### C

CE  
Declaration ..... 7

---

### F

FCC  
Declaration ..... 7

---

### I

Interfaces  
Overview ..... 10

---

### M

Mounting Holes ..... 11

---

### O

Operating Conditions  
Environmental Conditions ..... 19  
Outline  
Mechanical ..... 19

---

### R

RS232/RS485  
Connector Description ..... 14

---

### S

Signal naming  
Nomenclature ..... 12  
Software ..... 18  
Support ..... 21

---

### V

Version  
Product History ..... 22