

# BLUETECHNIX

## Embedding Ideas

### Sentis ToF - P509

### Hardware User Manual

Version 2

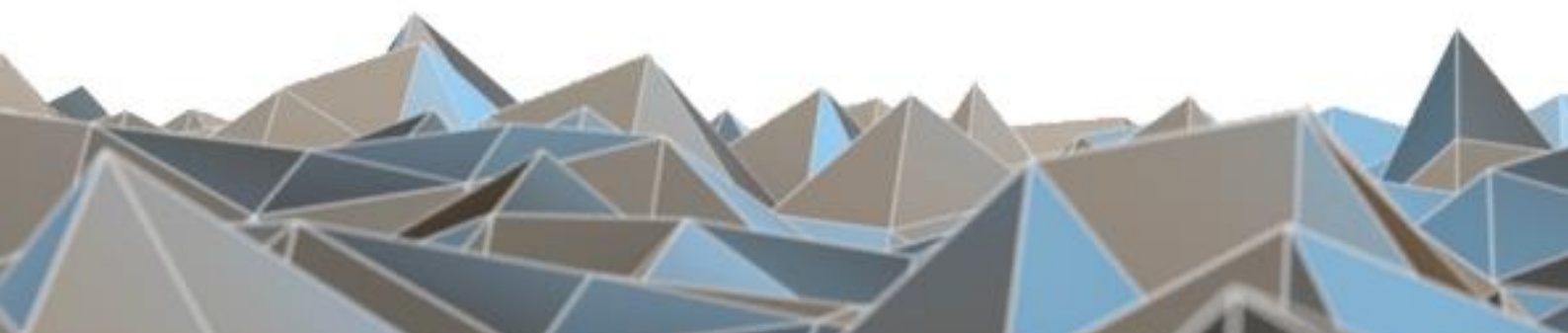



## Contact

Bluetechnix

Waidhausenstraße 3/19

A-1140 Vienna

AUSTRIA

[office@bluetechnix.com](mailto:office@bluetechnix.com)

<http://www.bluetechnix.com>

Date: 2015-06-02



## Table of Contents

1	General Information .....	6
1.1	Symbols Used .....	6
1.2	Certification .....	6
1.3	Safety instructions .....	7
1.4	Electrical connection .....	7
2	Introduction .....	8
2.1	Overview .....	8
2.2	Key Features .....	8
3	General Description .....	9
3.1	Functional Description .....	9
3.2	PCB description .....	9
3.3	Interfaces .....	9
3.3.1	Power connector .....	9
3.3.2	GBit-Ethernet .....	9
3.3.3	MicroSD-Card slot .....	10
3.3.4	Reset button .....	10
3.3.5	Power LED .....	10
4	Hardware installation .....	11
4.1	Mounting .....	11
4.2	Lenses and objective .....	11
4.3	Sensor sensitivity .....	11
4.4	Sensor Orientation .....	11
5	Specifications .....	12
5.1	Electrical Specifications .....	12
5.1.1	Operating Conditions .....	12
5.1.2	ESD Sensitivity .....	12
5.1.3	EMC .....	12
6	Connector Description .....	13
6.1	Power Connector (c) .....	13
6.2	GBit Ethernet Connector (d) .....	14
6.3	USB Host Connectors (a) .....	14
6.4	MicroSD-Card slot (b) .....	14
6.5	Reset Button (e) .....	14
7	Mechanical Outline .....	15
7.1	Top View .....	15
7.2	Bottom View .....	16



7.3	Side View.....	16
8	Product History .....	17
8.1	Version Information .....	17
8.1.1	Sentis ToF - P509 .....	17
8.2	Anomalies.....	17
9	Document Revision History.....	18
A	List of Figures and Tables.....	19



© Bluetechnix GmbH 2015

All Rights Reserved.

The information herein is given to describe certain components and shall not be considered as a guarantee of characteristics.

Terms of delivery and rights of technical change reserved.

We hereby disclaim any warranties, including but not limited to warranties of non-infringement, regarding circuits, descriptions and charts stated herein.

Bluetechnix makes and you receive no warranties or conditions, express, implied, statutory or in any communication with you. Bluetechnix specifically disclaims any implied warranty of merchantability or fitness for a particular purpose.

Bluetechnix takes no liability for any damages and errors causing of the usage of this board. The user of this board is responsible by himself for the functionality of his application. He is allowed to use the board only if he has the qualification. More information is found in the General Terms and Conditions (AGB).

#### Information

For further information on technology, delivery terms and conditions and prices please contact Bluetechnix (<http://www.bluetechnix.com>).

#### Warning

Due to technical requirements components may contain dangerous substances.

## 1 General Information

This guide applies to the Sentis ToF - P509 camera platform from Bluetechnix GmbH. Follow this guide chapter by chapter to set up and understand your product. If a section of this document only applies to certain camera parts, this is indicated at the beginning of the respective section.

**The document applies to X-Grade product from V0.0.0**

### 1.1 Symbols Used

This guide makes use of a few symbols and conventions:



#### Warning

Indicates a situation which, if not avoided, could result in minor or moderate injury and/or property damage or damage to the device.



#### Caution

Indicates a situation which, if not avoided, may result in minor damage to the device, in malfunction of the device or in data loss.



#### Note

Notes provide information on special issues related to the device or provide information that will make operation of the device easier.

#### Procedures

**A procedure always starts with a headline**

1. The number indicates the step number of a certain procedure you are expected to follow. Steps are numbered sequentially.

This sign ► indicates an expected result of your action.

#### References

 This symbol indicates a cross reference to a different chapter of this manual or to an external document.

### 1.2 Certification



#### X-Grade Version

X-Grade version of the products are not intended for sale and have therefore no certifications. The user is responsible for a correct usage in order with federal laws.

### 1.3 Safety instructions



#### Important

This manual is part of the device and contains information and illustrations about the correct handling of the device and must be read before installation or use. Observe the operating instructions. Non-observance of the instructions, operation which is not in accordance with use as prescribed below, wrong installation or handling can affect the safety of people and machinery.

The installation and connection must comply with the applicable national and international standards. Responsibility lies with the person installing the unit.

### 1.4 Electrical connection



#### Note

The unit must be connected by a qualified electrician.

Device of protection class III (PC III).

The electric supply must only be made via PELV circuits.

The device must only be powered by a limited energy source ( $\leq 30V$ ;  $\leq 8A$ ;  $\leq 100VA$ ).

Disconnect power before connecting the unit.



## 2 Introduction

### 2.1 Overview

The Sentis ToF - P509 is a depth sensor module, developed by Bluetechnix, operating on the Time-of-Flight (ToF) principle. The Sentis ToF - P509 is based on the ToF sensor 19k-S3 of PMDtec and Freescale i.MX6 processor. The camera consists of different modules from Bluetechnix like the TIM-uP-19k-S3-Spartan-6, LIM-u-LED-850 and CM-i.MX6x.

### 2.2 Key Features

- 3D depth sensor module TIM-uP-19k-S3-Spartan6 based on PMD PhotonICS® 19k-S3
- Symmetrical illumination by 2 x light modules LIM-u-LED-850
- Processor module CM-i.MX6Q based on Freescale i.MX6Q
- Up to 160fps, adjustable
- Gigabit Ethernet
- Support for 30°, 60° and 90° FOV (90° default)
- 3 x USB host interface
- MicroSD Card Slot
- Hardware reset with factory reset feature



## 3 General Description

### 3.1 Functional Description

The following image shows the block diagram of the Sentis ToF - P509.

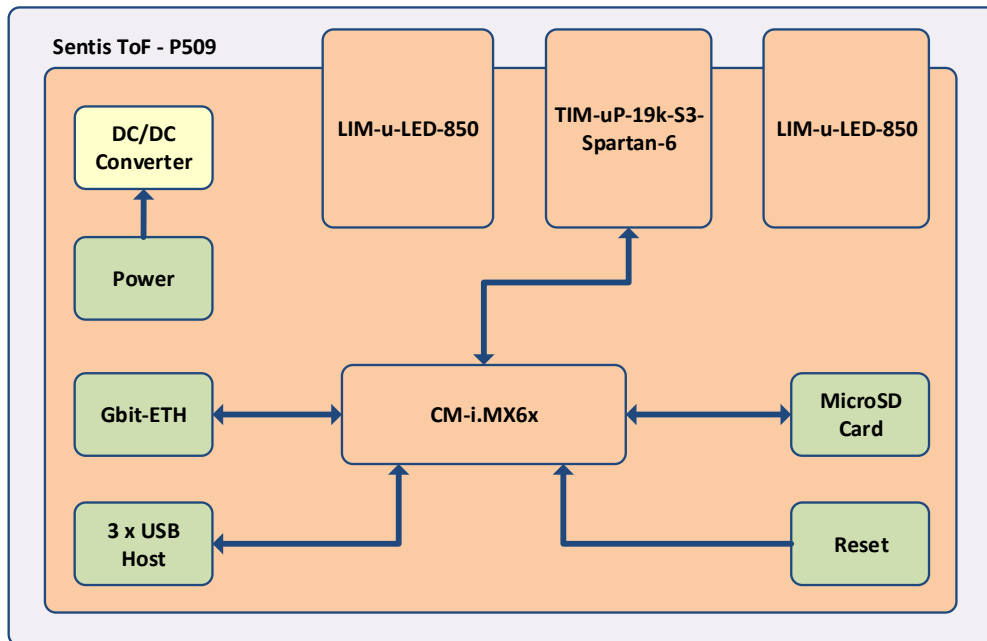

Figure 3-1 Sentis ToF - P509 block diagram

### 3.2 PCB description

The hardware is based on 5 PCBs. The PCBs are stacked like a sandwich:

- The CM-i.MX6x is mounted on the bottom of the Baseboard
- The TIM-uP-19k-S3-Spartan-6 is mounted on the Baseboard
- The two LIM-u-LED-850 are mounted on the Baseboard

### 3.3 Interfaces

The following chapters describes the interfaces on the Sentis ToF - P509.

#### 3.3.1 Power connector

The Sentis ToF - P509 must be powered by an external 18V-30V power supply connected to the 3.5mm terminal connector (see chapter 6.1).

#### 3.3.2 GBit-Ethernet

The Gbit-Ethernet interface from CM-i.MX6Q is available on a standard RJ45 connector (see chapter 6.2).



### **3.3.3 MicroSD-Card slot**

A MicroSD-Card slot is available on the Sentis ToF – P509.

The MicroSD-card is connected to USDHC1 interface of the CM-i.MX6Q (see chapter 6.2).

### **3.3.4 Reset button**

The reset button provides a hardware reset function. This button can also be used to perform a factory default reset by pressing the button until the CM-i.MX6Q has boot. The reset button is connected to the reset input of the CM-i.MX6Q and to the pin GPIO2\_14 of the i.MX6Q

### **3.3.5 Power LED**

The Power LED is ON when the Sentis ToF – P509 is powered by the external power supply.



## 4 Hardware installation

### 4.1 Mounting

TBD

The Sentis ToF - P509 provides 4 x M3 mounting holes to fix it on the enclosure. The positions of the mounting holes is shown in figure 7.1 (3.2mm holes).



**Note:**

The mounting holes must be electrically connected to the enclosure using metallic screws!

### 4.2 Lenses and objective

The Sentis ToF - P509 is equipped with a 90° objective for the TIM module and 90° lenses for the LIM modules. Other objectives/lenses can be provided by Bluetechnix on request.



**Note:**

Be aware that using different objectives and lenses for other FOVs leads to different objective/lenses height relative to the 3D sensor.

### 4.3 Sensor sensitivity

See Hardware User Manual of the TIM-uP-19k-S3-Spartan6 available from Bluetechnix website.

### 4.4 Sensor Orientation

See Hardware User Manual of the TIM-UP-19k-S3 USB 2.0 PVI available from Bluetechnix website.



## 5 Specifications

### 5.1 Electrical Specifications

#### 5.1.1 Operating Conditions

Symbol	Parameter	Min	Typical	Max	Unit
$V_{IN}$	Input supply voltage	18	24	30	V
$I_{IN}$	Input current	-	2	3.5	A
$T_{OP}$	Operating Temperature	0	-	60 <sup>1)</sup>	°C
$T_{STG}$	Storage Temperature	-65	-	150	°C
<b>FITP</b>	Frame-rate Integration Time Product	-	TBD	-	

Table 5-1 Electrical characteristics

- <sup>1)</sup> Depends on cooling mechanism. Be aware that the stated maximum operating temperature is not intended for any kind of development KIT. The maximum operating temperature for development KIT is 30°C.

#### 5.1.2 ESD Sensitivity



**ESD (electrostatic discharge) sensitive device.** Charged devices and circuit boards can discharge without detection. Although this product features patented or proprietary protection circuitry, damage may occur on devices subjected to high energy ESD. Therefore, proper ESD precautions should be taken to avoid performance degradation or loss of functionality.

#### 5.1.3 EMC

The system is intended for light industrial environments according to the following normative:

EN55022 class A, EN55024:2010

Only pre-compliance measurements according to the above stated normative will be performed on the system. The customer responsible for the final product is also responsible to fulfill all regulations requested by law.



## 6 Connector Description

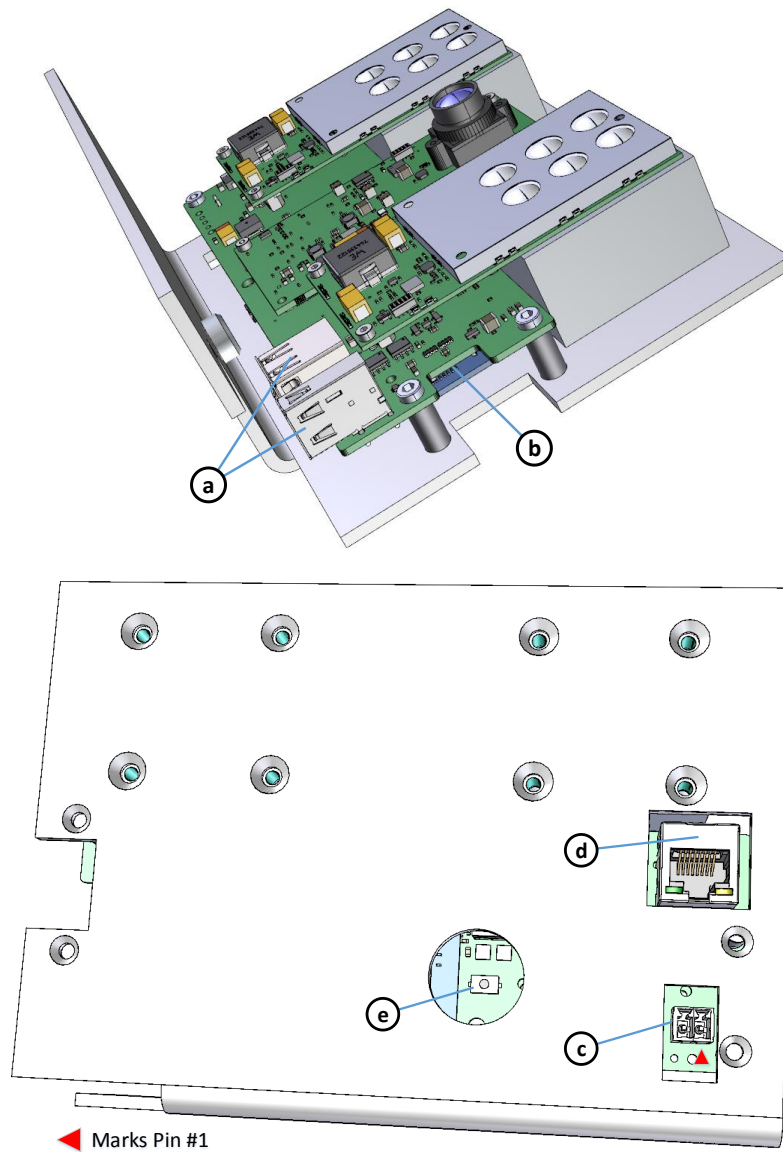

Figure 6-1 Connectors of the Sentis ToF - P509

### 6.1 Power Connector (c)

This 3.5mm terminal connector allows plugging a cable entry plug like: **691361100002** from Würth Elektronik. Compatible connectors from other manufacturers may be found as well.

Pin #1 is the positive supply voltage, pin #2 is power ground. This pins are protected against wrong polarity.

Voltage range: 18V to 30V.

**!** **Note**  
Use inherently limited power sources only!

## 6.2 GBit Ethernet Connector (d)

This is a standard straight RJ45 10/100/1000 Base-T compatible Ethernet connector.

## 6.3 USB Host Connectors (a)

This USB-A connectors provides 3 USB2.0 interfaces through the on-board USB-Hub.

**!** **Note**  
The maximum power consumption of all devices powered by the 3 USB ports cannot exceed 5W! No power limited devices are provided on-board to avoid overload (>5W).

## 6.4 MicroSD-Card slot (b)

This MicroSD-Card-Slot provides a mass storage interface to the CM-i.MX6Q through the USDHC1 port. MicroSD cards up to SDXC capacity are supported by the CM-i.MX6Q.

## 6.5 Reset Button (e)

This reset button provides a hardware reset function and factory reset function (see chapter 3.3.4).

## 7 Mechanical Outline

A 3D STEP model of the Sentis ToF - P509 can be provided by Bluetechnix on request.

### 7.1 Top View

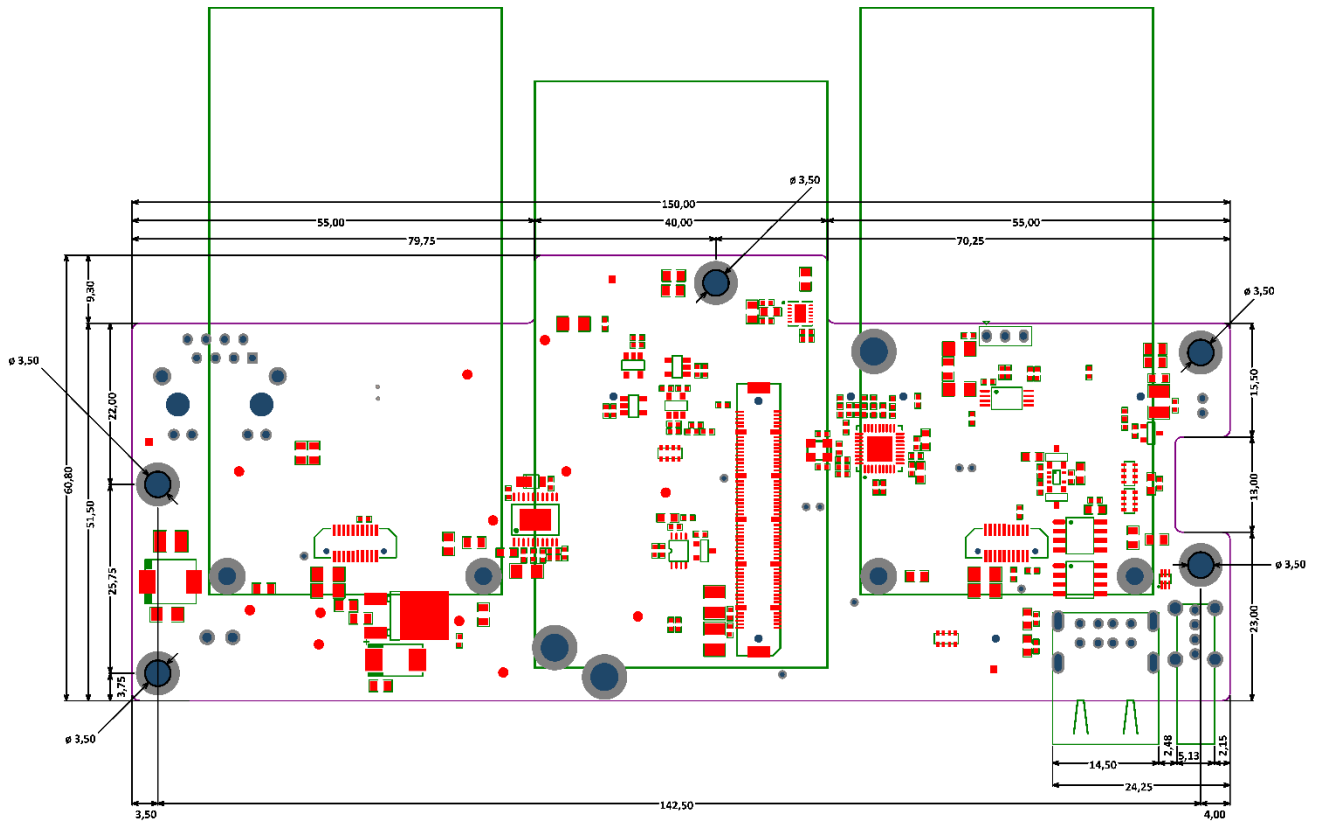

Figure 7-1 Top View of the Sentis ToF - P509-Baseboard



## 7.2 Bottom View

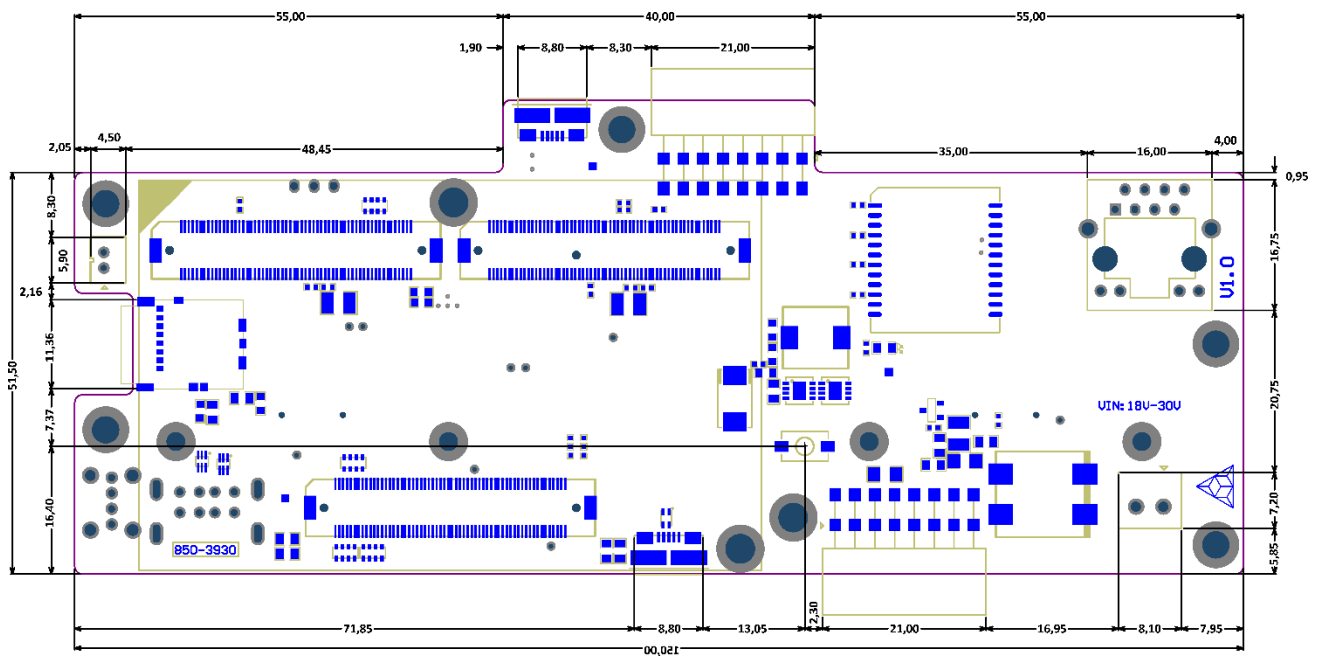

Figure 7-2 Bottom View of the Sentis ToF - P509-Baseboard

## 7.3 Side View

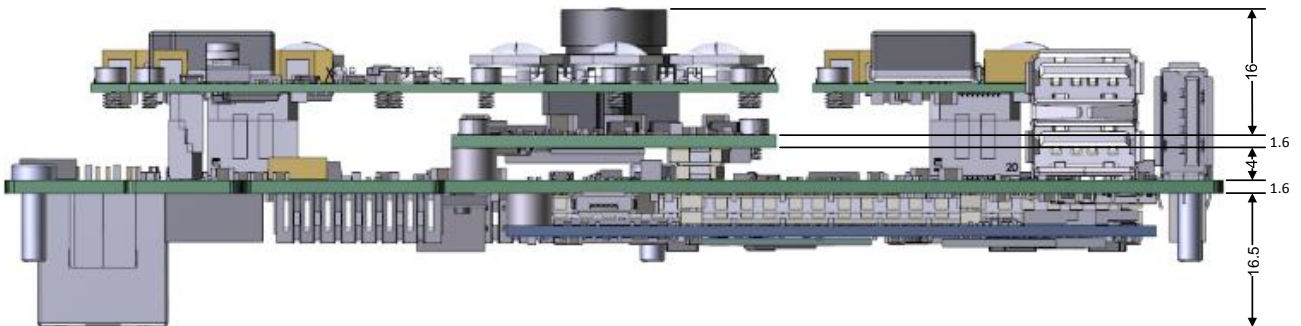

Figure 7-3 Side view of the Sentis ToF - P509 without case





## 8 Product History

### 8.1 Version Information

#### 8.1.1 Sentis ToF - P509

Version	Component	Type
0.0.0	TIM	Bluetechnix TIM-uP-19k-S3 V2.0
	LIM	Bluetechnix LIM-U-LED-850 V1.1
	CM-i.MX6Q	Bluetechnix CM-i.MX6Q-C-I-Q24S2048F2N4096 V1.2
	5V Controller	Texas Instruments LM25116MH/NOPB
	USB-HUB	SMSC USB2514B-AEZG

Table 8-1 Overview Sentis ToF - P509 product changes

### 8.2 Anomalies

Version	Date	Description
V0.0	2015 06 02	On short interruptions on mains (>300ms; <2000ms) it may occur that the Sentis-P509 doesn't restart anymore after power on mains returns. <u>Workaround:</u> Detach the camera from power for ~5 seconds.

Table 8-2 Product anomalies



## 9 Document Revision History

Version	Date	Document Revision
1	2015 03 18	First release V1.0 of the document
2	2015 06 02	Anomaly list updated. Operating conditions updated. Document version adjusted to new scheme.

Table 9-1 Revision history



## A List of Figures and Tables

### Figures

Figure 3-1 Sentis ToF - P509 block diagram .....	9
Figure 6-1 Connectors of the Sentis ToF - P509 .....	13
Figure 7-1 Top View of the Sentis ToF - P509-Baseboard .....	15
Figure 7-2 Bottom View of the Sentis ToF - P509-Baseboard .....	16
Figure 7-3 Side view of the Sentis ToF - P509 without case .....	16

### Tables

Table 5-1 Electrical characteristics .....	12
Table 8-1 Overview Sentis ToF - P509 product changes .....	17
Table 8-2 Product anomalies .....	17
Table 9-1 Revision history .....	18